

300 DGC

(Membrangerät)

MAßZEICHNUNG

HIRLEKAR
PRECISION

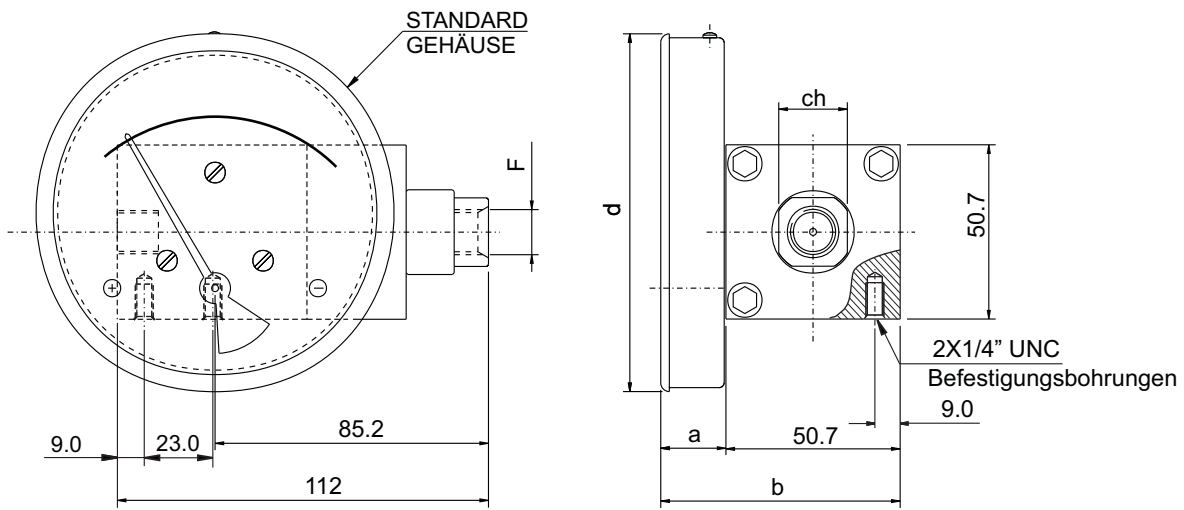

DIAL Ø	F	a	b	d	ch
63 (2.5")	1/4"BSP - 1/4"NPT	19	69.7	66	20
80 (3.5")	1/4"BSP - 1/4"NPT	19	69.7	83	20
100 (4")	1/4"BSP - 1/4"NPT	19	69.7	104.3	20
115(4.5")	1/4"BSP - 1/4"NPT	19	69.7	119.7	20
150(6")	1/4"BSP - 1/4"NPT	19	69.7	154.3	20

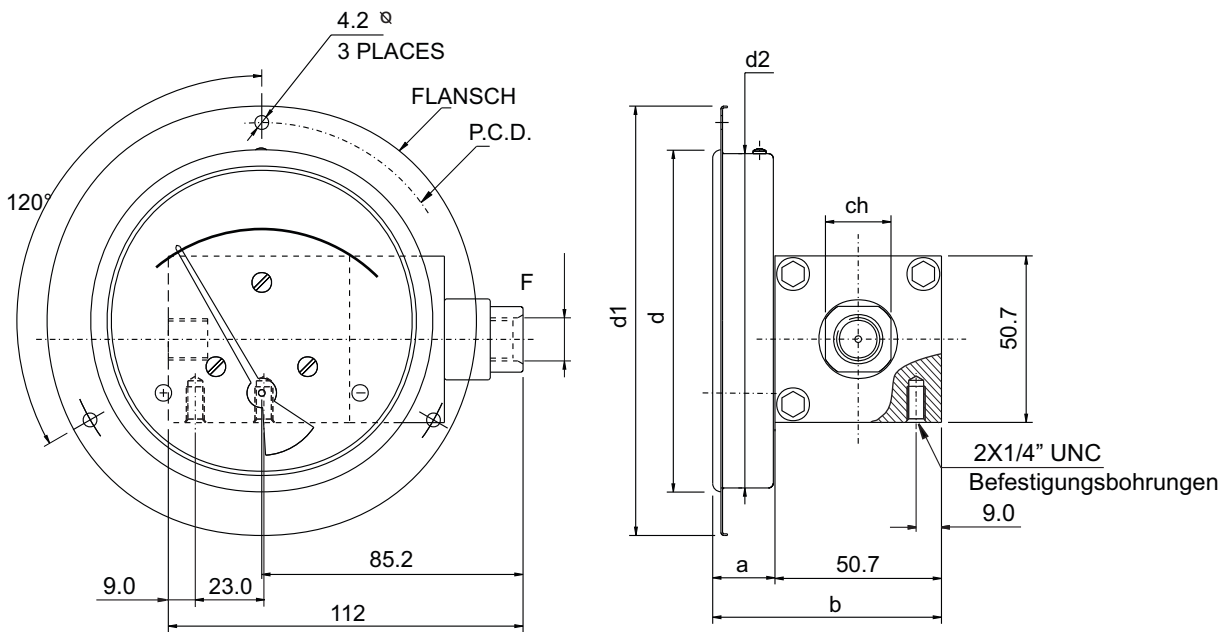

DIAL Ø	F	a	b	d1	d2	ch	p.c.d.	d *
63(2.5")	1/4"BSP - 1/4"NPT	19	69.7	93	65	20	83	66
80(3.5")	1/4"BSP - 1/4"NPT	19	69.7	109	82	20	99	83
100(4")	1/4"BSP - 1/4"NPT	19	69.7	131	102	20	121	104.3
115(4.5")	1/4"BSP - 1/4"NPT	19	69.7	146	117	20	136	119.7
150(6")	1/4"BSP - 1/4"NPT	19	69.7	181	152.5	20	171	154.3

* PANEL CUTOUT = d +1

Manometer+Reedschalter mit DIN-Stecker, Klemmleiste

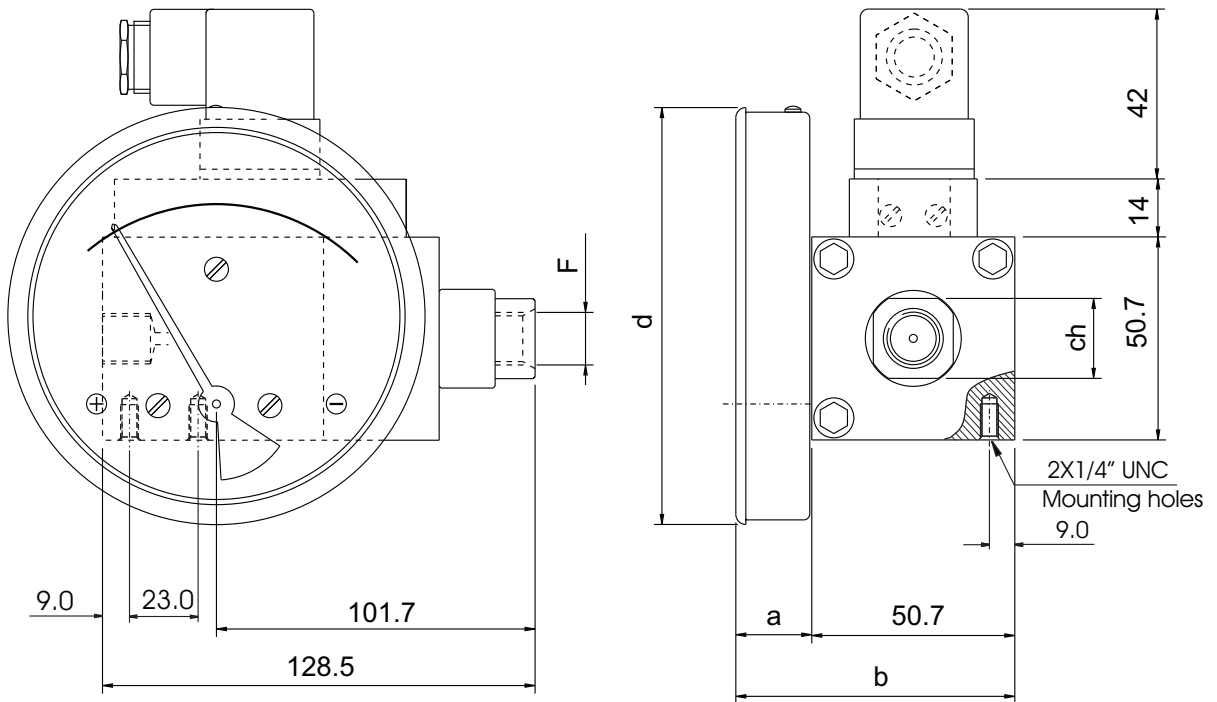

DIAL \varnothing	F	a	b	d	ch
63	1/4"BSP - 1/4"NPT	19	69.7	66	20
80	1/4"BSP - 1/4"NPT	19	69.7	83	20
100	1/4"BSP - 1/4"NPT	19	69.7	104.3	20
115	1/4"BSP - 1/4"NPT	19	69.7	119.7	20
150	1/4"BSP - 1/4"NPT	19	69.7	154.3	20

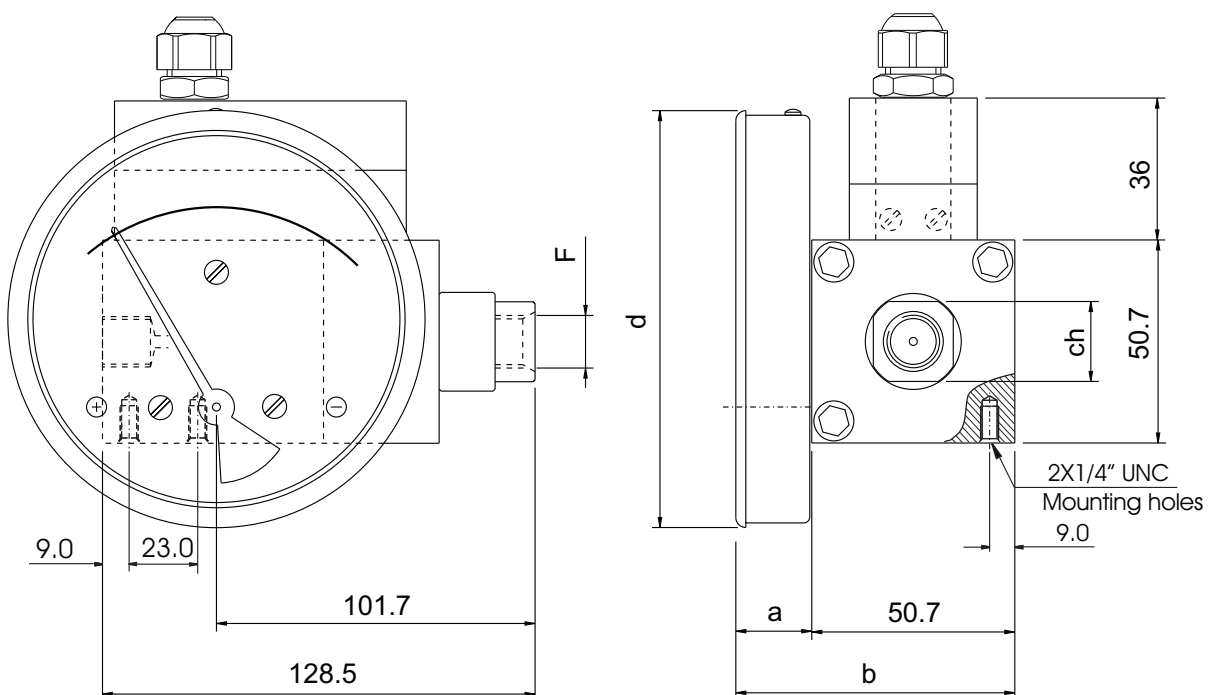

Manometer+Reedschalter mit Klemmleiste und 1/2" NPT Kanalanschluss

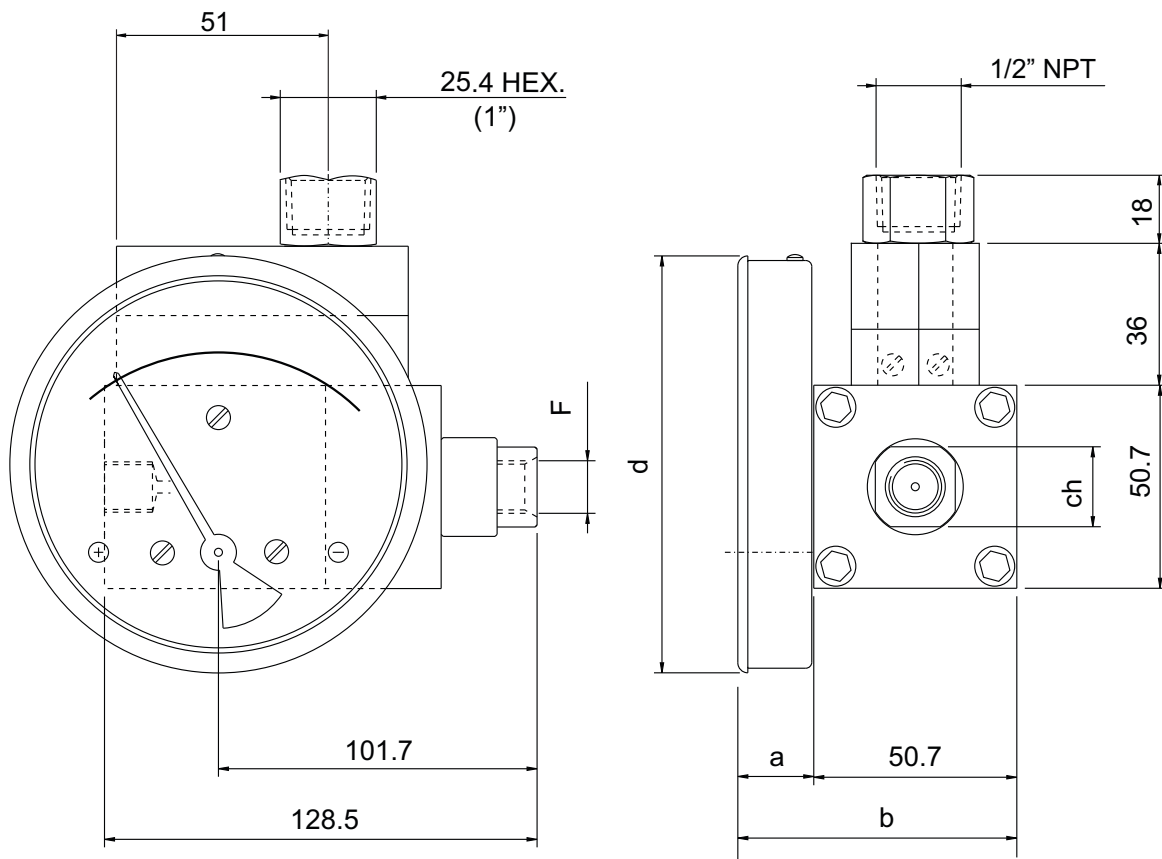

DIAL Ø	F	a	b	d	ch
63	1/4"BSP - 1/4"NPT	19	69.7	66	20
80	1/4"BSP - 1/4"NPT	19	69.7	83	20
100	1/4"BSP - 1/4"NPT	19	69.7	104.3	20
115	1/4"BSP - 1/4"NPT	19	69.7	119.7	20
150	1/4"BSP - 1/4"NPT	19	69.7	154.3	20

Schalter

mit Klemmleiste

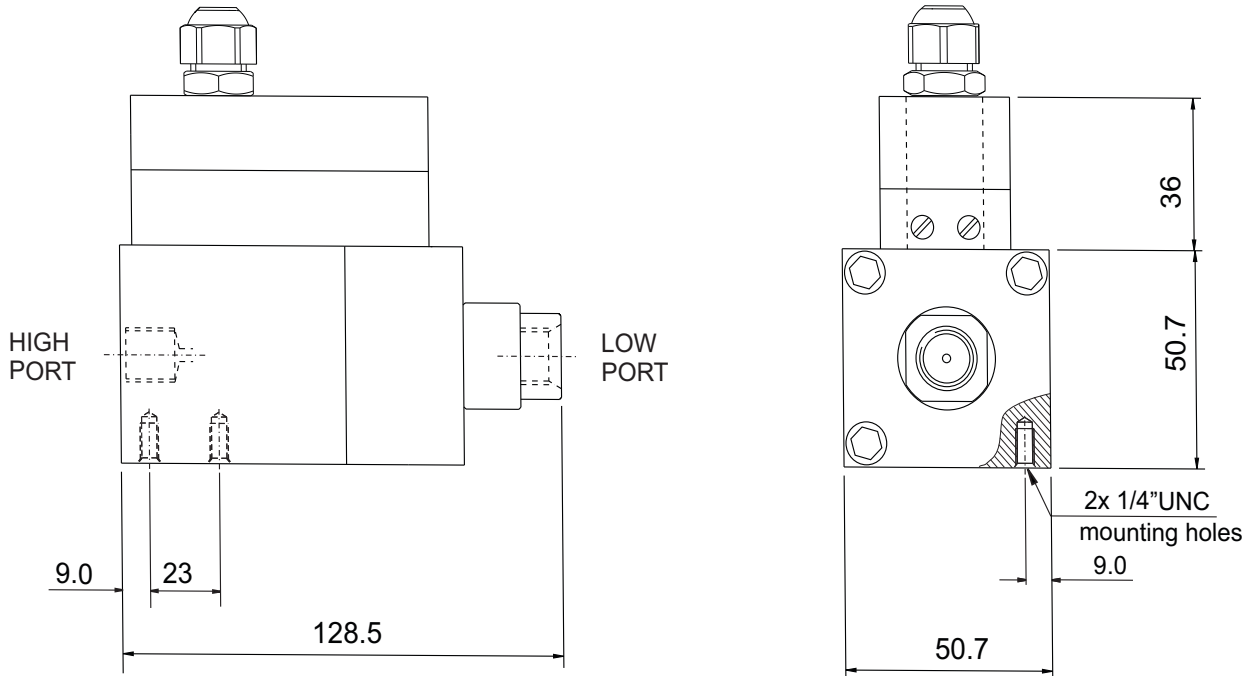

mit DIN-Stecker

