

700 DGC (Membrangerät) MONTAGE

HIRLEKAR
PRECISION

Aufbaumontage

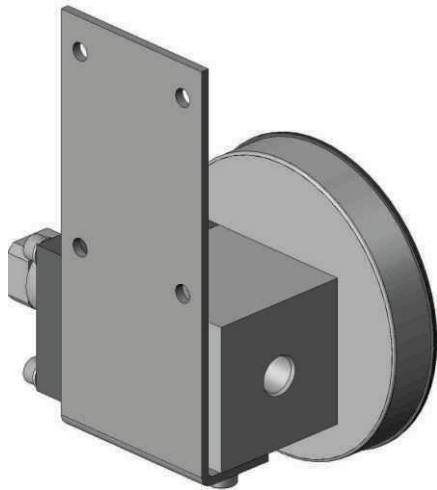

Horizontale Rohrmontage



Vertikale Rohrmontage

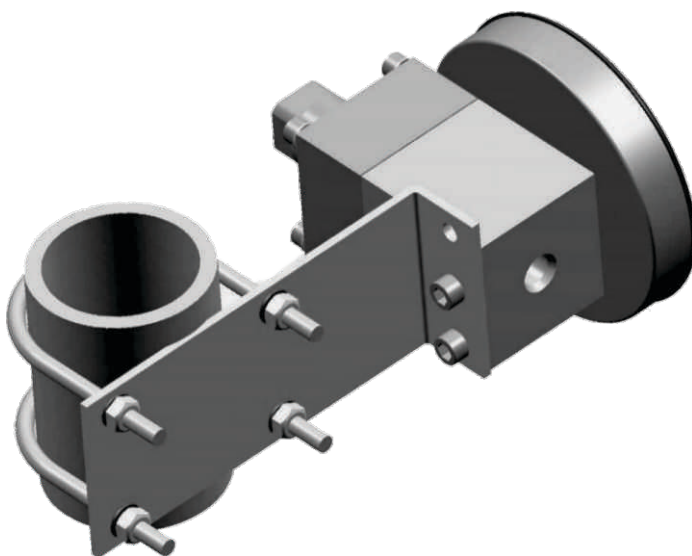

Tafeleinbau / Flanschbefestigung

