

EX 400DGC

(Membrangerät)

MONTAGE

HIRLEKAR
PRECISION

Aufbaumontage

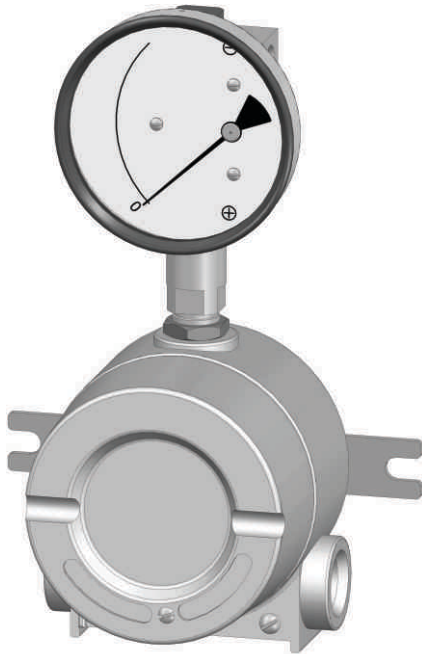

Horizontale Rohrmontage

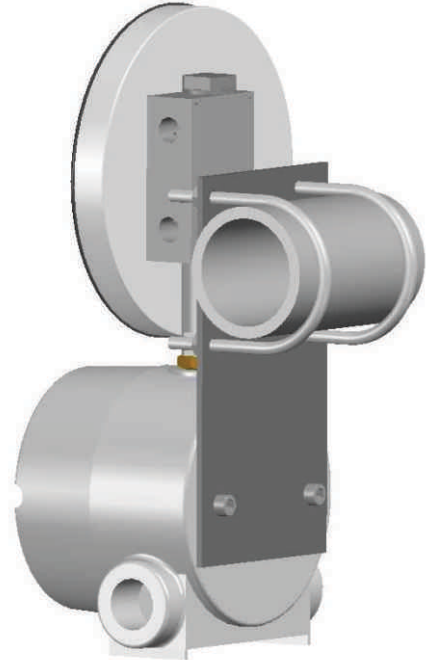

Vertikale Rohrmontage

