

700 DGC (Diaphragm Gauge) PORTING DETAILS

HIRLEKAR
PRECISION

Back porting

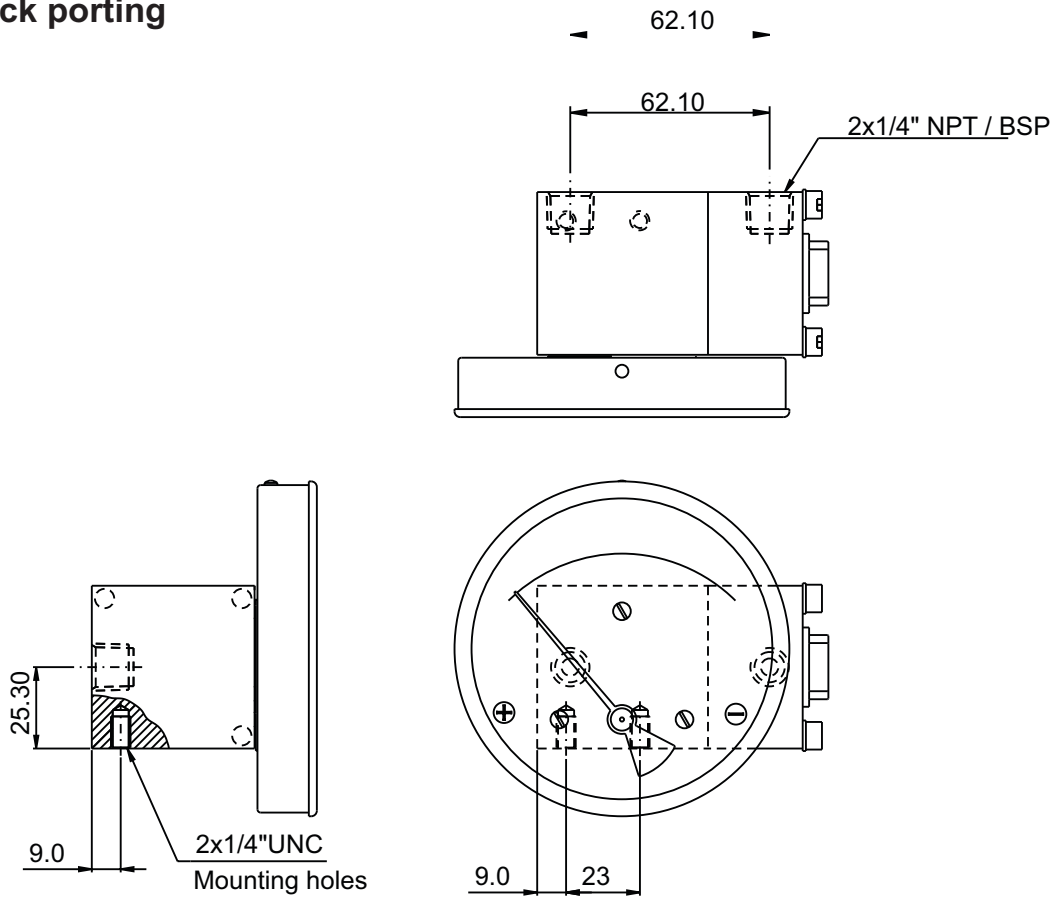

Bottom porting

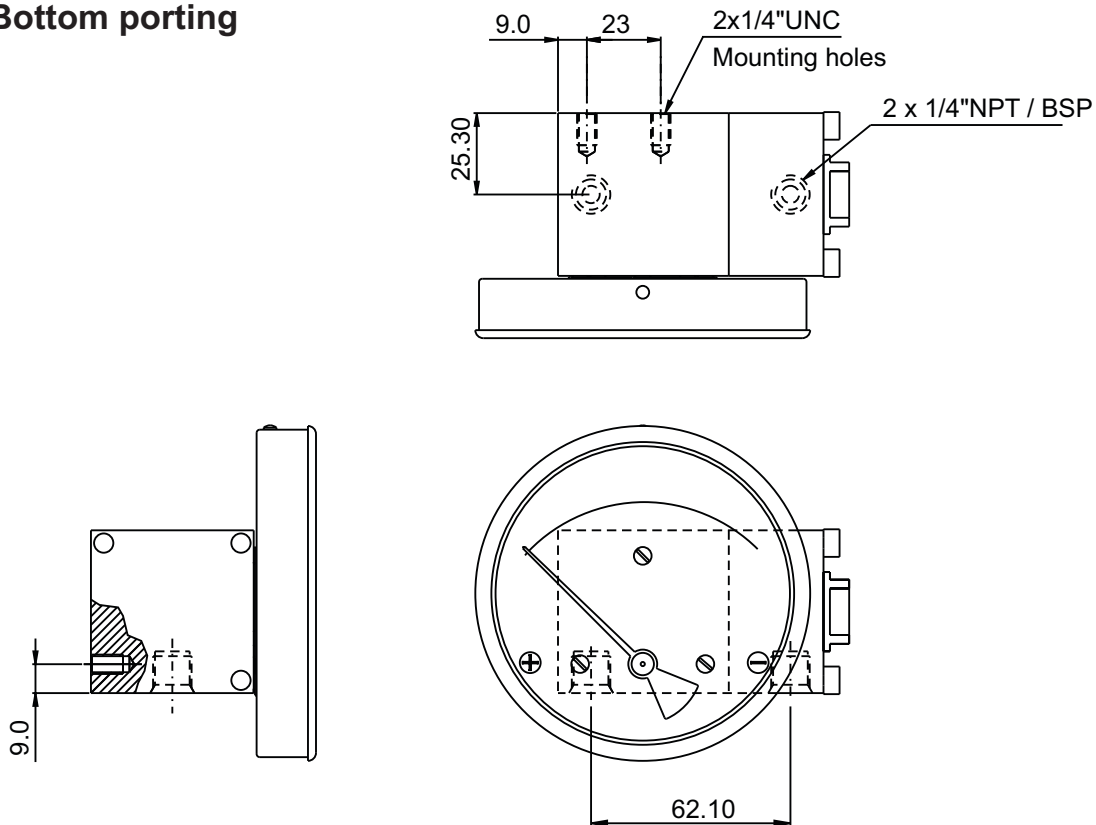

NOTE : 2x1/4" UNC MOUNTING HOLES PROVIDED ON REQUEST.